

# OptiLine

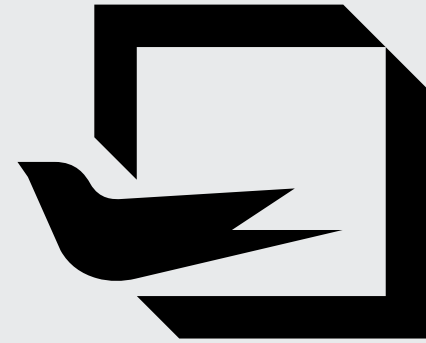

OPENING  
NEW  
HORIZONS

+29  
years of experience

+55.000  
square meters

+2.500  
partners



Optimedia has been producing PVC and Aluminum joineries since 1994, amassing an impressive and modern production system. Since 2006, we have started exporting our products currently having more than 2.500 B2B partners worldwide.

**OUR VISION:**

To be a leader in the production of PVC and Aluminum joineries, offering support to all our partners. To achieve this, we have kept to our core principles, maintaining the quality of our products and the relationships with our partners as top priorities.

**OUR MISSION:**

To produce windows and doors that have certified and proven characteristics, manufactured and delivered to the highest market standards.

SUPPLIERS



REYNAERS, is a european leader specialized in the development of innovative and sustainable aluminum solutions. Their product offering ranges from curtain walls to windows, doors and even sliding or folding joinery systems.

[reynaers.com](http://reynaers.com)



CORTIZO has consolidated its leading position on the aluminum market for architecture and construction profiles through massive investments that have allowed it to create a complete range of solutions for windows, facades and state-of-the-art solar protection systems.

[cortizo.com](http://cortizo.com)



GUARDIAN GLASS is one of the largest and most innovative glass manufacturers in the world. Founded in 1932 in Detroit, Michigan, the company operates on five continents, serving more than 160 countries.

[guardianglass.com](http://guardianglass.com)



SAINT-GOBAIN GLASS is the european leader in the production of construction glass. The factory in Călărași, Romania, has the most modern float glass production line in Europe. The thermal, acoustic and security performances of SAINT-GOBAIN glazings recommends them for the most creative and original architectural solutions.

[saint-gobain-glass.com](http://saint-gobain-glass.com)



In recent years, ALIPLAST has become one of the leading international players in the development and production of aluminum systems for windows, doors, verandas and curtain walls. Innovation, design, technical competence and quality are decisive in this development.

[aliplast.com](http://aliplast.com)



WINKHAUS develops, manufactures and sells hardware for windows and doors, together with automatic closing, access and security systems. The german WINKHAUS group was founded in 1854, remaining a family business with over 2.000 partners worldwide.

[winkhaus.com](http://winkhaus.com)

# OptiLine

IMPERIAL 65

## PRODUCT GEOMETRY

Frame depth: **65 mm**  
Sash depth: **74 mm**  
3 sealing gaskets

## MAXIMUM INSULATING GLASS UNIT THICKNESS

**51 mm**

## THERMAL PERFORMANCE

**$U_w \geq 1,57 \text{ W/m}^2\text{K}$**

## ACOUSTIC INSULATION

**43 dB**

## CERTIFICATIONS

Air resistance: **Class 4**  
Water resistance: **Class E1350**  
Wind resistance: **Class C4**

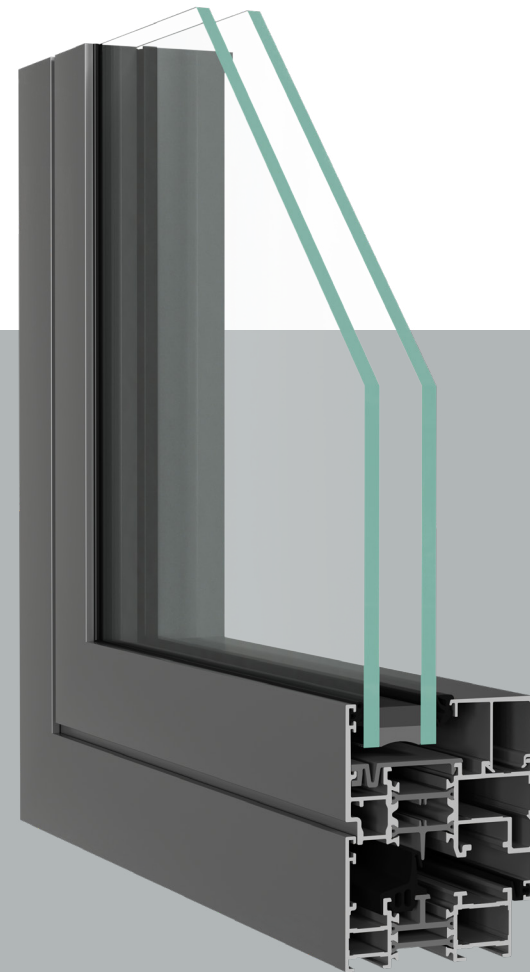

\* THE PHOTOS ARE FOR INFORMATIONAL PURPOSES ONLY

**aliplast**  
aluminium systems

This system, suitable for windows, doors and shop fronts, stands out through its superior thermal insulation, thanks to special thermal inserts. Its profiles are versatile and can be used with various peripheral accessories, including hidden hinges and even PVC hardware. The system allows the production of modern windows with varied designs, making it suitable for various residential and public projects.



# OptiLine

IMPERIAL 65 HO (HIDDEN SASH)

## PRODUCT GEOMETRY

Frame depth: **65 mm**  
Sash depth: **68 mm**  
3 sealing gaskets

## MAXIMUM INSULATING GLASS UNIT THICKNESS

**41 mm**

## THERMAL PERFORMANCE

**$U_w \geq 1,63 \text{ W/m}^2\text{K}$**

## ACOUSTIC INSULATION

**40 dB**

## CERTIFICATIONS

Air resistance: **Class 4**  
Water resistance: **Class E1200**  
Wind resistance: **Class C5**

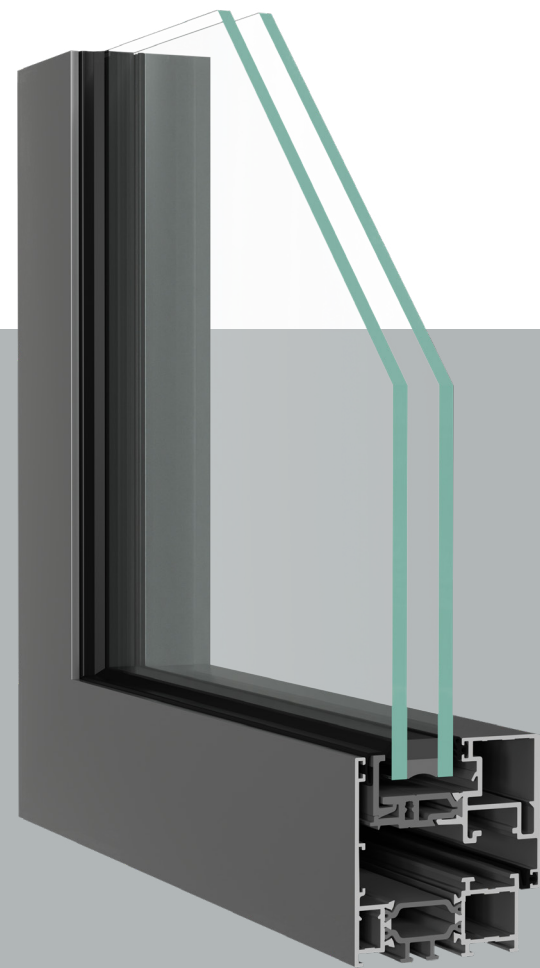

\* THE PHOTOS ARE FOR INFORMATIONAL PURPOSES ONLY

**aliplast**  
aluminium systems

This system, suitable for windows, doors and shop fronts, stands out through its superior thermal insulation, thanks to special thermal inserts. Its profiles are versatile and can be used with various peripheral accessories, including hidden hinges and even PVC hardware. The system allows the production of modern windows with varied designs, making it suitable for various residential and public projects.



# OptiLine

ECOFUTURAL 65

## PRODUCT GEOMETRY

Frame depth: **65 - 153 mm**  
Sash depth: **74 mm**  
2 sealing gaskets

## MAXIMUM INSULATING GLASS UNIT THICKNESS

**59 mm**

## THERMAL PERFORMANCE

**$U_w \geq 1,5 \text{ W/m}^2\text{K}$**

## ACOUSTIC INSULATION

**42 dB**

## CERTIFICATIONS

Air resistance: **Class 4**  
Water resistance: **Class 9A**  
Wind resistance: **Class C4**

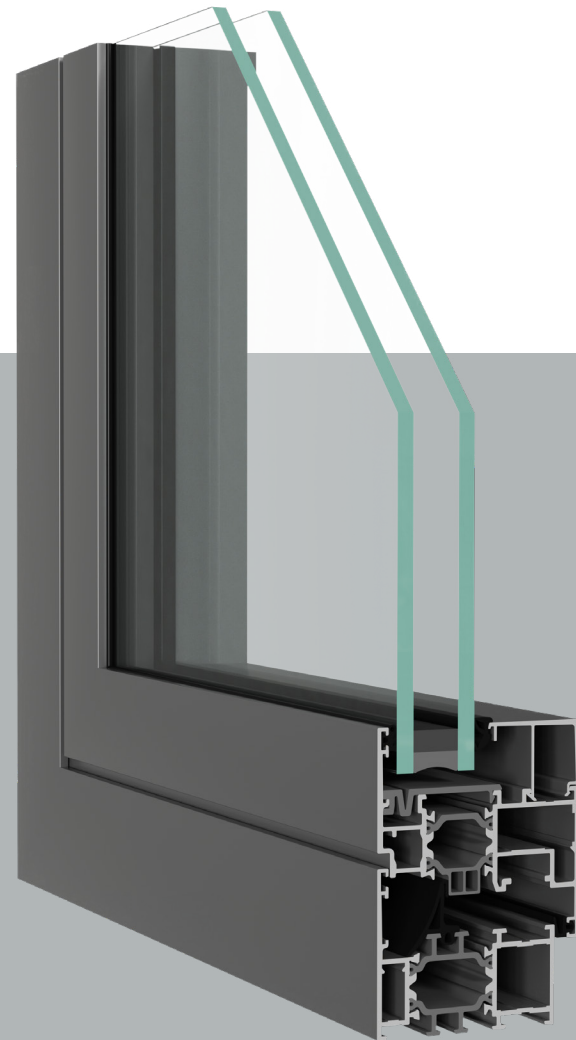

\* THE PHOTOS ARE FOR INFORMATIONAL PURPOSES ONLY

**aliplast**  
aluminium systems

An optimal three-chambered windows and doors system offering superior thermal performance and design flexibility. The Ecofutural variant comes with two extra options to improve thermal performance, making it ideal for more demanding projects. The hidden sash variant provides an elegant aesthetic which, when combined with the minimalist 77 mm moving mullion, gives rise to a clutterless and bright aesthetic.



©AGSF

# OptiLine

COR 60 CE

## PRODUCT GEOMETRY

Frame depth: **60 mm**  
Sash depth: **68 mm**  
3 sealing gaskets

## MAXIMUM INSULATING GLASS UNIT THICKNESS

**46 mm**

## THERMAL PERFORMANCE

**$U_w \geq 1,0 \text{ W/m}^2\text{K}$**

## ACOUSTIC INSULATION

**48 dB**

## CERTIFICATIONS

Air resistance: **Class 4**  
Water resistance: **Class E1350**  
Wind resistance: **Class C5**

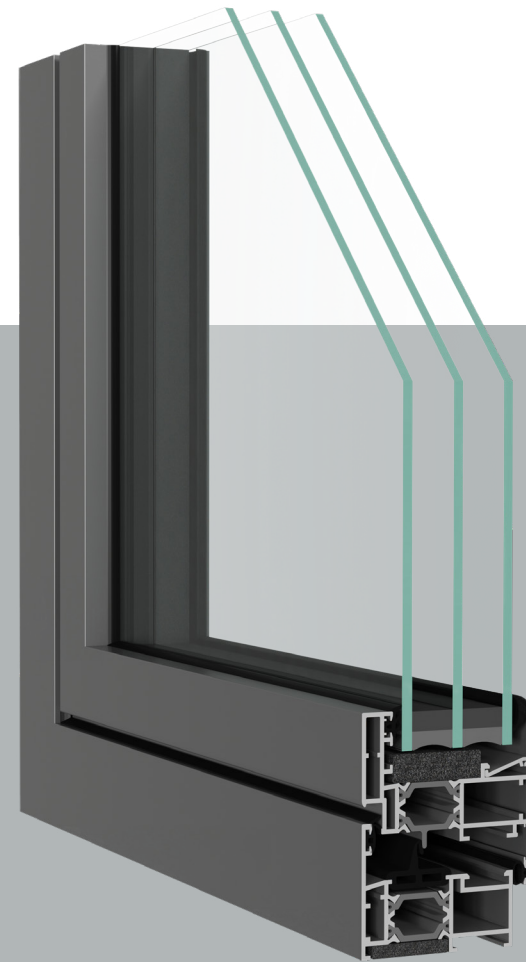

\*THE PHOTOS ARE FOR INFORMATIONAL PURPOSES ONLY



Cor 60 is an innovative window and door system with a frame depth of 60 mm and a 24 mm polyamide thermal barrier, offering remarkable thermal and acoustic comfort whilst reducing noise by up to 48 dB. This system comes with additional options for high-security hardware and hidden hinges, meeting even the most demanding requirements in terms of insulation, durability and design.





# OptiLine

COR 2300

## PRODUCT GEOMETRY

Frame depth: **40 mm**  
Sash depth: **48 mm**  
2 sealing gaskets

## MAXIMUM INSULATING GLASS UNIT THICKNESS

**26 mm**

## THERMAL PERFORMANCE

**$U_w \geq 2,0 \text{ W/m}^2\text{K}$**

## ACOUSTIC INSULATION

**39 dB**

## CERTIFICATIONS

Air resistance: **Class 4**  
Water resistance: **Class 9A**  
Wind resistance: **Class C5**

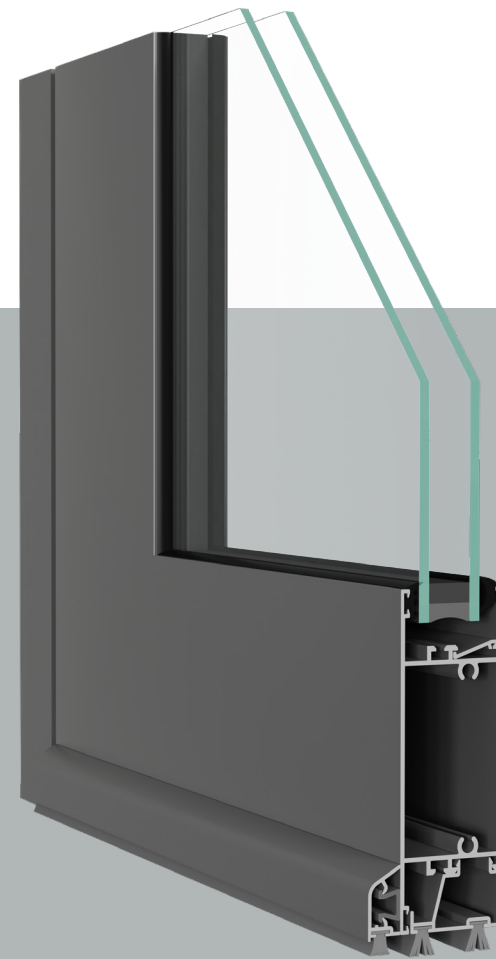

\* THE PHOTOS ARE FOR INFORMATIONAL PURPOSES ONLY



Cor 2300 is a hinged windows and doors system distinguished by its 40 mm deep frame and the reduced overall thickness resulting from it. It therefore offers multiple advantages in terms of aesthetics and functionality. Nevertheless, the system gives you multiple options to improve security, with dedicated hardware and hidden hinges, whilst maintaining a clean and modern look.



# OptiLine

COR 2000

## PRODUCT GEOMETRY

Frame depth: **40 / 45 / 60 / 70 mm**  
Sash depth: **26 mm**  
with brushes

## MAXIMUM INSULATING GLASS UNIT THICKNESS

**16 mm**

## THERMAL PERFORMANCE

**$U_w \geq 2,9 \text{ W/m}^2\text{K}$**

## ACOUSTIC INSULATION

**33 dB**

## CERTIFICATIONS

Air resistance: **Class 3**  
Water resistance: **Class 8A**  
Wind resistance: **Class C5**



Cor 2000 is an innovative sliding system for a unique and versatile design. It provides flexibility in shape and appearance allowing for straight, angled and curved sashes. Therefore, it is adaptable for various projects, ensuring a perfect fit between appearance and functionality.

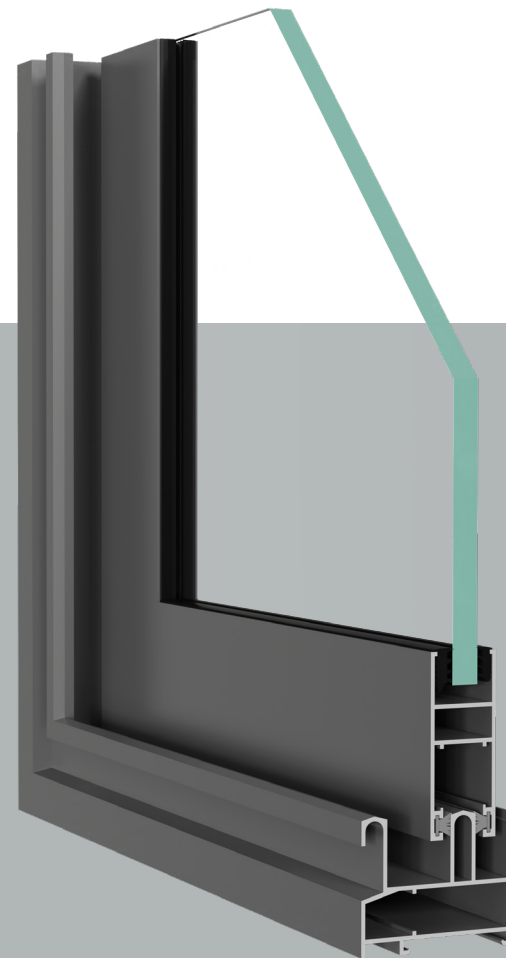

\* THE PHOTOS ARE FOR INFORMATIONAL PURPOSES ONLY



# OptiLine

COR 4200

## PRODUCT GEOMETRY

Frame depth: **60 / 65 / 67 / 80 mm**  
Sash depth: **33 / 37 mm**  
with brushes

## MAXIMUM INSULATING GLASS UNIT THICKNESS

**23 mm**

## THERMAL PERFORMANCE

**$U_w \geq 1,5 \text{ W/m}^2\text{K}$**

## ACOUSTIC INSULATION

**39 dB**

## CERTIFICATIONS

Air resistance: **Class 3**  
Water resistance: **Class 7A**  
Wind resistance: **Class C5**

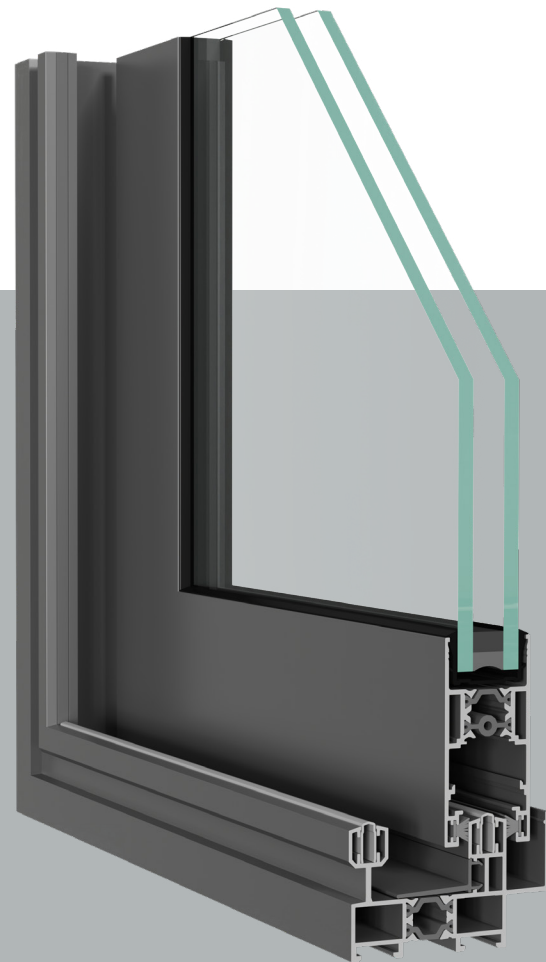

\* THE PHOTOS ARE FOR INFORMATIONAL PURPOSES ONLY



Cor 4200 is an in-line sliding windows and doors system, standing out through its versatility and the possibility of generating gallandage openings, obtaining 100% openings by allowing the sashes to slide into the neighbouring walls. This option allows the configuration of balcony doors with 1, 2 or 4 hidden sashes.



# OptiLine

COR 4700

## PRODUCT GEOMETRY

Frame depth: **115 / 120 mm**  
Sash depth: **50 mm**  
with brushes

## MAXIMUM INSULATING GLASS UNIT THICKNESS

**36 mm**

## THERMAL PERFORMANCE

**$U_w \geq 1,1 \text{ W/m}^2\text{K}$**

## ACOUSTIC INSULATION

**40 dB**

## CERTIFICATIONS

Air resistance: **Class 3**  
Water resistance: **Class 7A**  
Wind resistance: **Class C5**

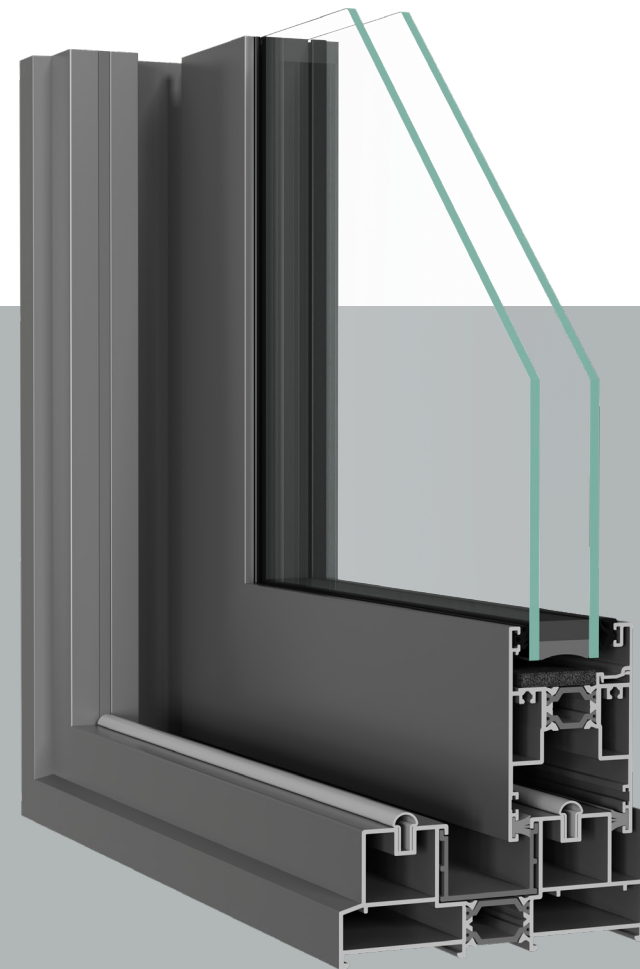

\* THE PHOTOS ARE FOR INFORMATIONAL PURPOSES ONLY



Thanks to its minimalist aesthetics, with a central node of only 47 mm, Cor 4700 is a sliding windows and doors system specifically designed for large glazed areas that nevertheless improves a building's thermal and acoustic performances. The sashes can support loads up to 280 kg, allowing generous dimensions of up to 2500 mm x 3000 mm to be created. Combining refined aesthetics with impressive performance Cor 4700 is suitable for any interior or exterior design project.



# OptiLine

COR 4900

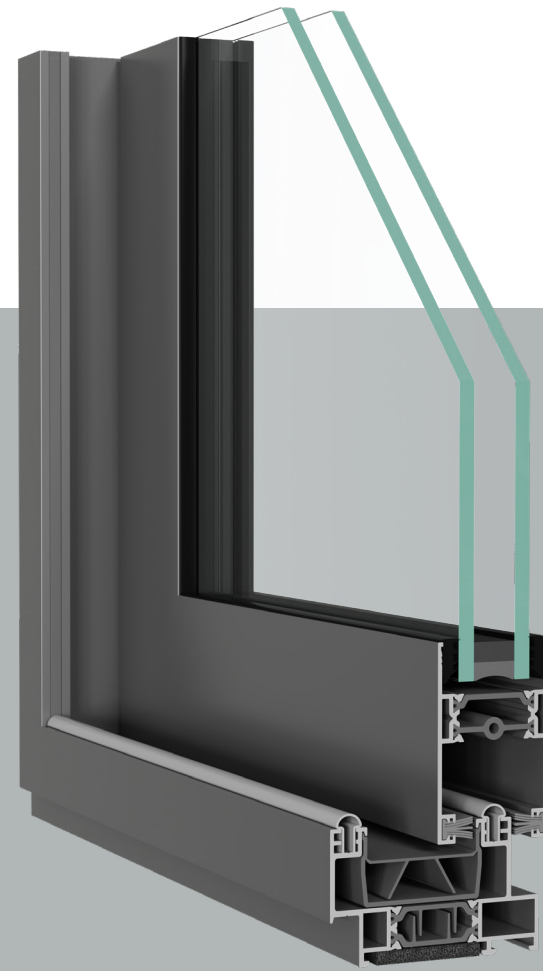

## PRODUCT GEOMETRY

Frame depth: **70 mm**  
Sash depth: **48 mm**  
with brushes

## MAXIMUM INSULATING GLASS UNIT THICKNESS

**36 mm**

## THERMAL PERFORMANCE

**$U_w \geq 1,2 \text{ W/m}^2\text{K}$**

## ACOUSTIC INSULATION

**40 dB**

## CERTIFICATIONS

Air resistance: **Class 4**  
Water resistance: **Class 7A**  
Wind resistance: **Class C5**



The 4900 sliding windows and doors system, with its minimalist design and straight lines, has a visible area amounting to only 35 mm. It stands out through the possibility of using insulating glass units up to 36 mm thick which significantly improve thermal and acoustic performances. Each sash can support loads of up to 240 kg, facilitating the creation of large elements up to 2200 mm x 2600 mm. It is an excellent choice for projects aimed at enhancing light and efficiency, both indoors and outdoors.

\* THE PHOTOS ARE FOR INFORMATIONAL PURPOSES ONLY



# OptiLine

## SLIM PATIO 68

### PRODUCT GEOMETRY

Frame depth: **120 mm**  
Sash depth: **38 mm**  
2 sealing gaskets

### MAXIMUM INSULATING GLASS UNIT THICKNESS

**38 mm**

### THERMAL PERFORMANCE

**$U_w \geq 1,4 \text{ W/m}^2\text{K}$**

### ACOUSTIC INSULATION

**40 dB**

### CERTIFICATIONS

Air resistance: **Class 4**  
Water resistance: **Class 8A**  
Wind resistance: **Class C4**



SlimPatio 68 is an extremely thin sliding doors solution offering excellent thermal insulation together with improved comfort and appearance. With a minimalist look, these premium sliding doors optimize the natural light passing into the room and offer exceptional panoramic views. Thanks to this innovative system, the indoor experience becomes brighter and more connected to the outside environment.

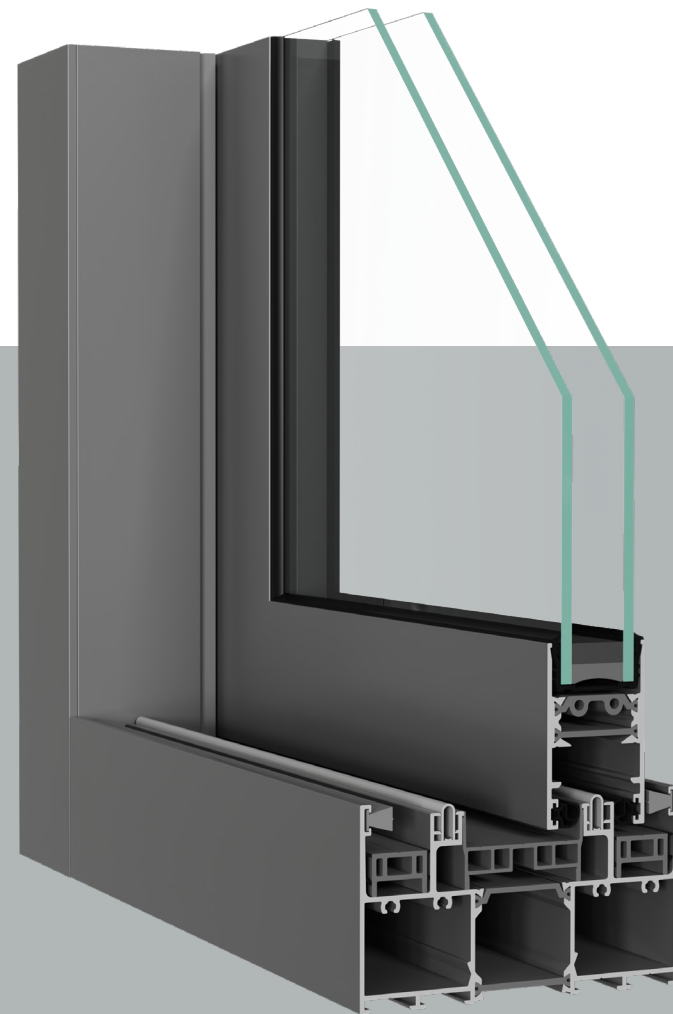

\*THE PHOTOS ARE FOR INFORMATIONAL PURPOSES ONLY



# OptiLine

## MODERN SLIDE



### PRODUCT GEOMETRY

Frame depth: **60 mm**  
Sash depth: **68 mm**  
with brushes

### MAXIMUM INSULATING GLASS UNIT THICKNESS

**32 mm**

### THERMAL PERFORMANCE

**$U_w \geq 0,8 \text{ W/m}^2\text{K}$**

### ACOUSTIC INSULATION

**48 dB**

### CERTIFICATIONS

Air resistance: **Class 4**  
Water resistance: **Class E1350**  
Wind resistance: **Class C5**

**aliplast**  
aluminium systems

Modern Slide is a sliding system suitable for both private residences and public buildings, bringing with it noticeable thermal performance improvements. The gallandage solution allows the sashes to be completely hidden in the walls therefore achieving a 100% opening. Available in 2, 3 and 4-way versions, it brings versatility to facade design. With profiles only 35 mm wide joining neighbouring elements, this system perfectly combines elegance with performance.

\* THE PHOTOS ARE FOR INFORMATIONAL PURPOSES ONLY



# Glass



Glass represents approximately 80% of the a joinery's surface. OPTIMEDIA equips its products with SAINT GOBAIN GLASS or GUARDIAN glazings that meet the thermal, acoustic and security requirements, whilst ensuring the desired indoor ambiance. Their winter-summer comfort function maintains a pleasant interior atmosphere throughout the year, with the sheen of its coating giving the space a touch of elegance.

## TECHNICAL SPECIFICATIONS

ESG tempered glass is, on average, 4 times more resistant than a standard glass to changes in temperature, strong winds and impacts. When cracked, it breaks down into small pieces without any sharp edges.

Laminated glass is composed of two or more simple glass sheets glued together with a PVB film which, in case of breakage acts as a medium to which the shards remain glued, therefore preventing possible accidents.

Tempered glass aims to protect both users against accidents and buildings against break-ins.

For design purposes or to protect you from prying eyes, Optimedia offers you a wide range of decorative glass with a large number of models, textures and colors.

Also, for added style and elegance, you can choose between georgian and astragal bars. These can be of different sizes, colors and shapes, made of PVC or Aluminum.

# Tempered glass: Optimedia ESG

ESG is a type of glass that, following the tempering process, shows a considerably higher resistance to mechanical and thermal stresses compared to ordinary glass (including laminated glass). In case of breakage, ESG glass fragments into small pieces with blunt edges. Its superior mechanical properties recommend it for large glazed elements.

## USES:

**Architectural:** all types of interior or exterior windows, doors and glass assemblies, consisting of independent or linked elements, facades, glazed roofs, stairs and even glass floors;

**Urban furniture:** telephone booths, public transport stations, parapets;

**Interior furniture:** table tops, shower cabins, shelves, furniture.

## WHY ESG (TEMPERED) GLASS?



ESG glass is 50% lighter than laminated glass, thus facilitating its transport and assembly whilst at the same time extending the joinery's life by reducing the load on the hardware.



It is 5 times more resistant to tension, shocks and bending stresses compared to an ordinary or laminated glass of the same thickness.



It reduces the risk of injury in case of breakage, by fragmenting into small, blunt pieces and limits the risk of break-ins.





OptiFusion IMPERIAL 65

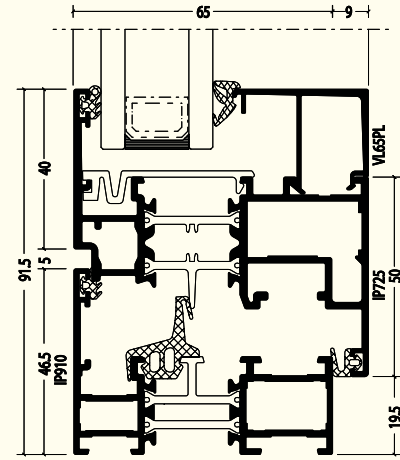

OptiFusion IMPERIAL 65 HO

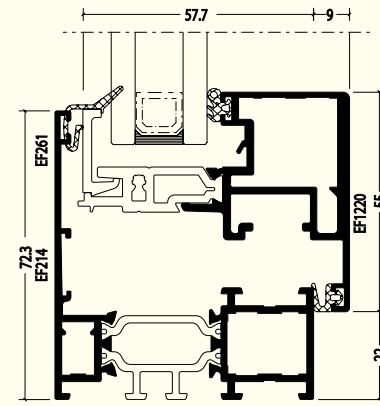

OptiFusion COR 60 CE

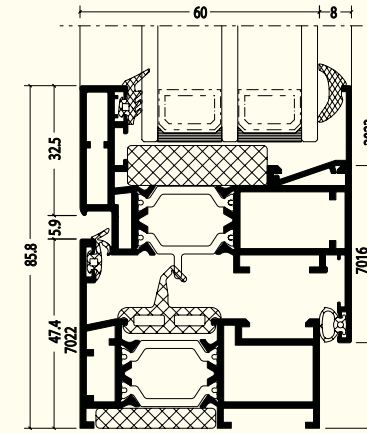

OptiFusion ECOFUTURAL 65

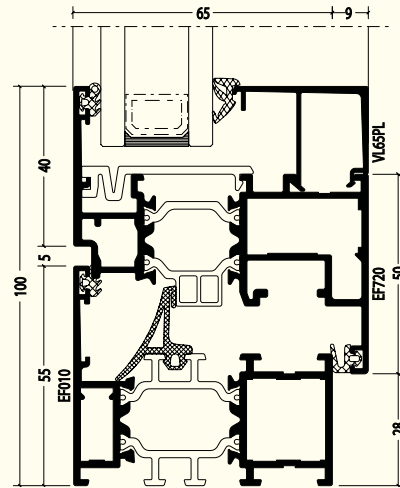

OptiFusion CORTIZO 2300

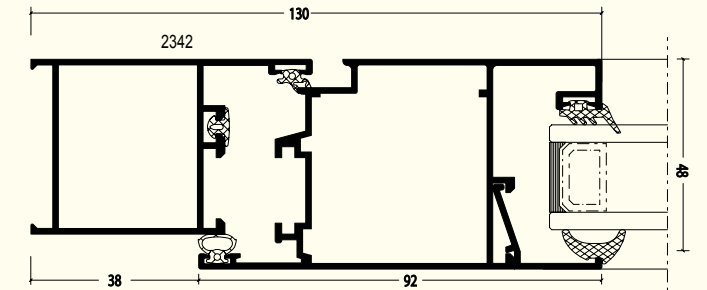
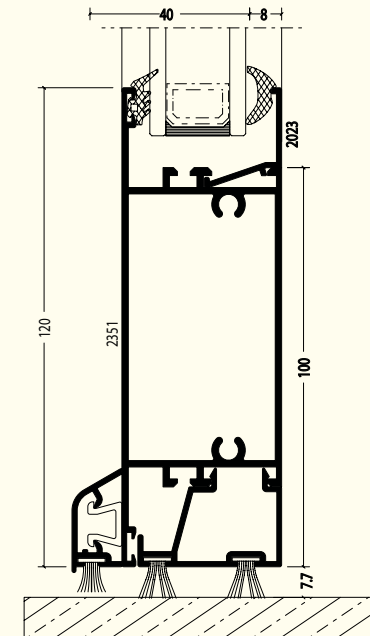

OptiFusion CORTIZO 2000

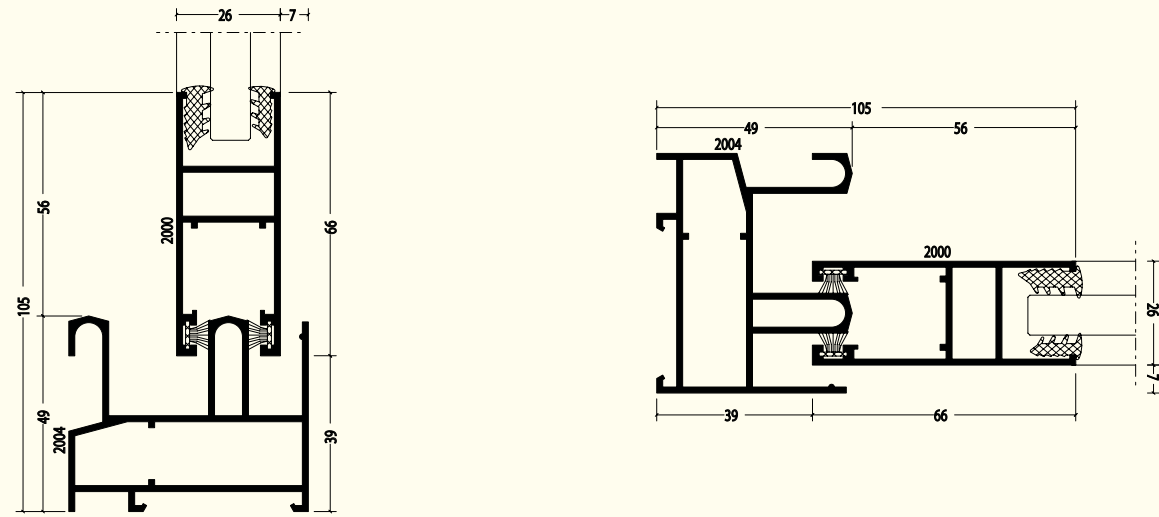

OptiFusion CORTIZO 4700

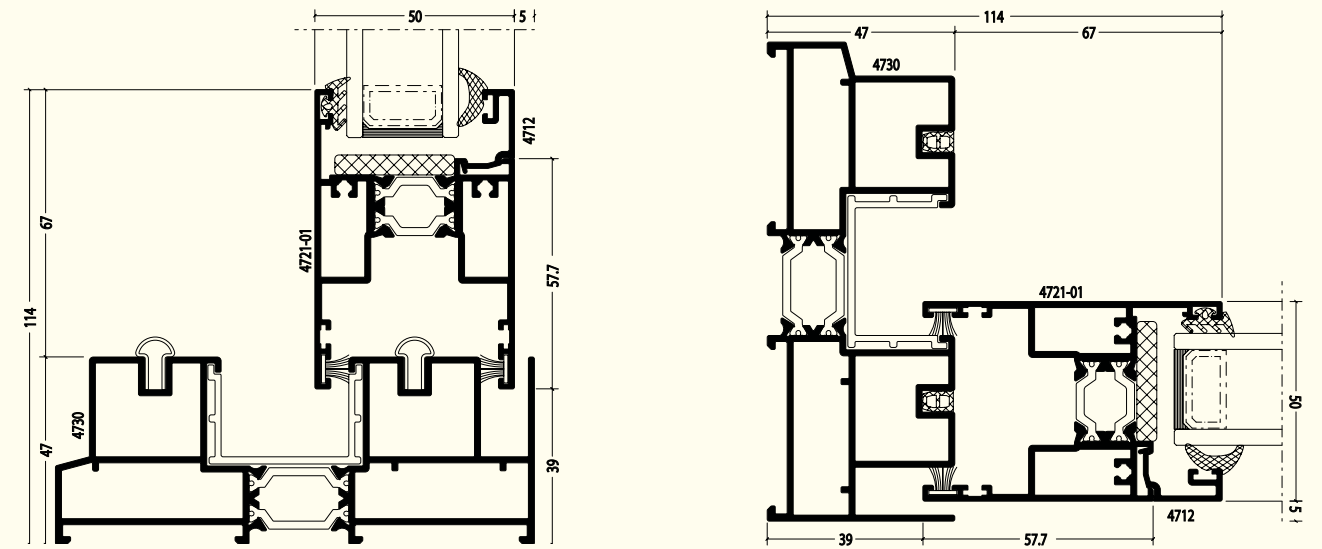

OptiFusion CORTIZO 4200

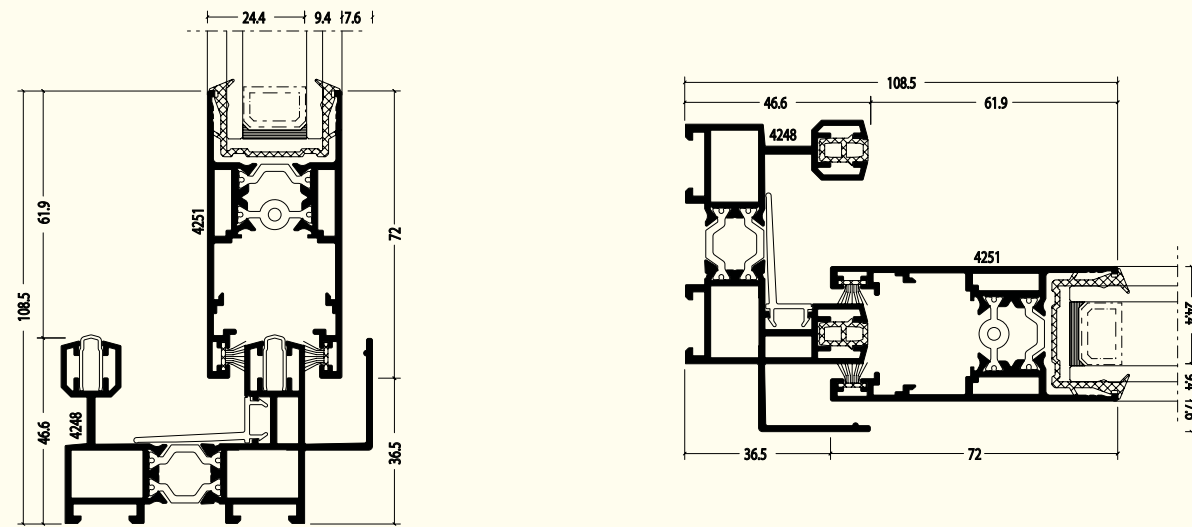

OptiFusion CORTIZO 4900

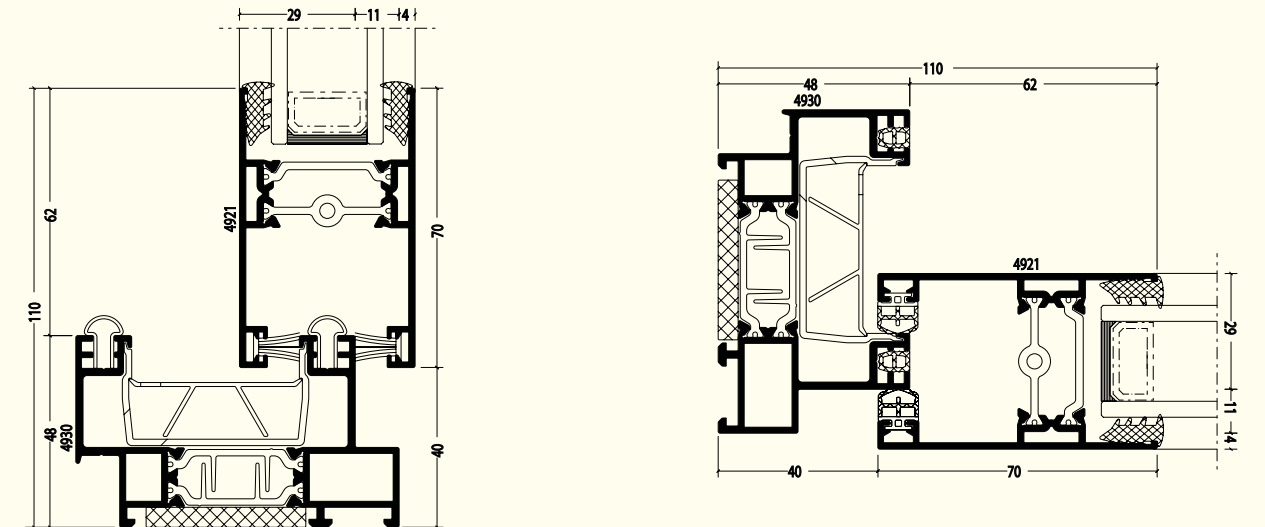

OptiFusion SP 68

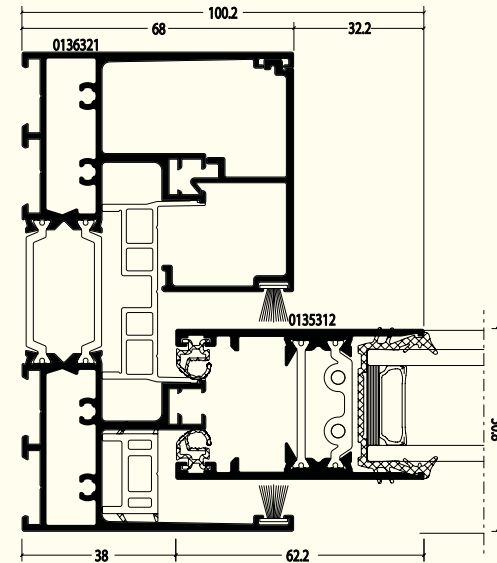
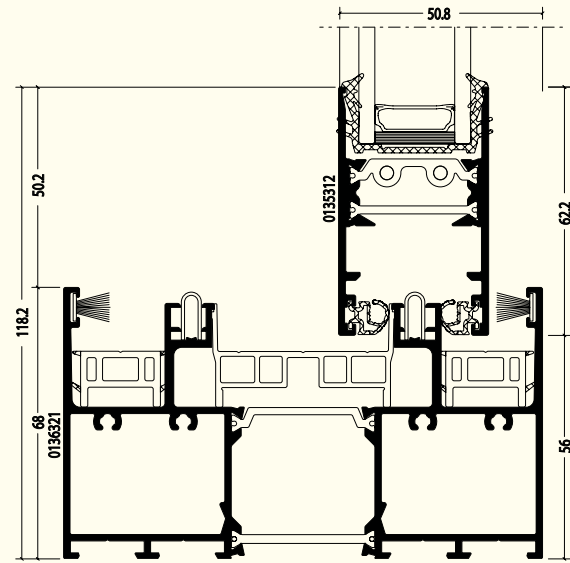

OptiLine MODERN SLIDE

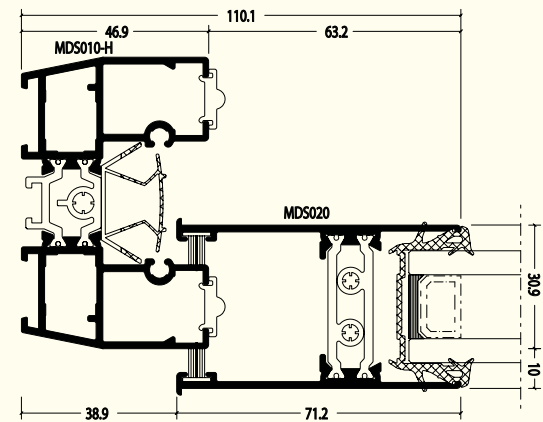
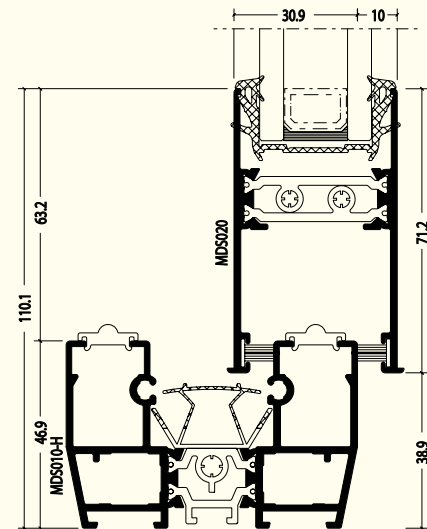

# Join the Optimedia team

We are constantly recruiting agents to represent Optimedia. We export to all continents and offer extensive sales support and packages so you can be an exceptional dealer in your area.



## Contact

 [optimedia](#)

 [Optimedia SRL](#)

 [optimedia.eu](#)

 [optimedia.eu](#)





S.C. OPTIMEDIA S.R.L.  
Calea Sântandrei, nr. 38  
410238, Oradea, România  
+40 259 442 821  
worldwide@optimedia.eu

[optimedia.eu](http://optimedia.eu)